

# EFD 30

## Ferrite Transformers

### Dati tecnici / Technical data

Conformità norme EN 61558 / EN 61558 approved

Marchio CE; classe B / CE mark; class B

Ferriti marcate / Marked ferrites

Tensione di isolamento 3750 VAC / Insulation voltage 3750 VAC

Frequenza nominale fino a 500KHz / Nominal frequency up to 500KHz

Temperatura ambiente 40 °C / Ambient temperature 40 °C

Conforme alla direttiva RoHS / RoHS conform

Grado di protezione IP00 / Degree of protection IP00

Rocchetto singola camera / Single chamber coilformer

Avvolgimenti in rame smaltato classe H / Class H enamelled copper wire coils

Immersione in vernice / Dipping in varnish

Test elettrici sul 100% della produzione / 100% tested production

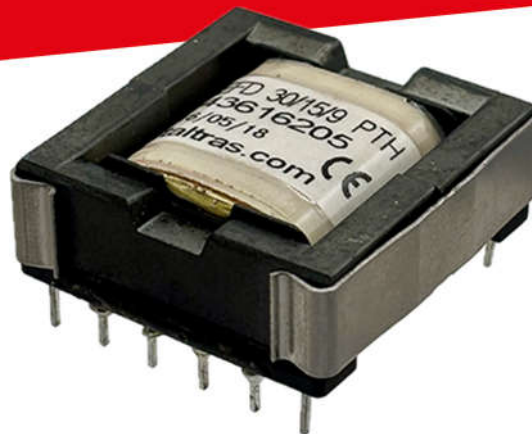

### Trasformatori in ferrite EFD30 – EFD30 ferrite transformers

Code	Model	Frequency Hz	Number of windings	External shield	Mounting	UL materials	Potting	N. Pins	Weight Gr
On request	EFD30	Up to 500KHz	On request	On request	Horizontal	Yes	On request	12	38

Su richiesta anche rocchetti a doppia camera / Double chamber coil former also available on request

Diametro di foratura PCB consigliato almeno 1.5mm / Recommended PCB drilling diameter at least 1.5mm

Gli ingombri del trasformatore finito corrispondono alle dimensioni massime del rocchetto /

The dimensions of the transformer correspond to the maximum dimensions of the coil former

### Dimensioni fisiche in mm / Physical dimensions in mm

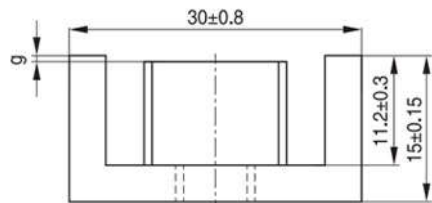

#### Coil former

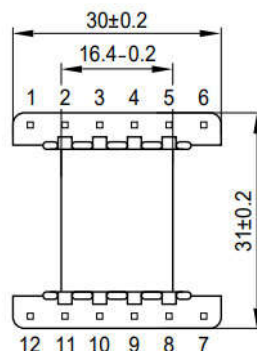

Dimensions 31.9 x 32.6 x h 13.0

#### Mounting holes

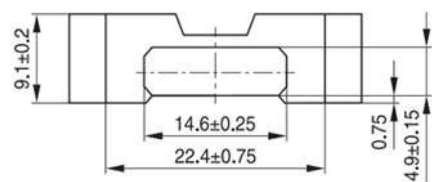
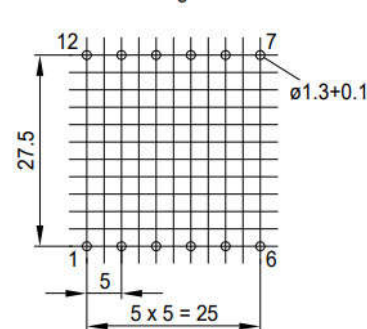

#### Yoke

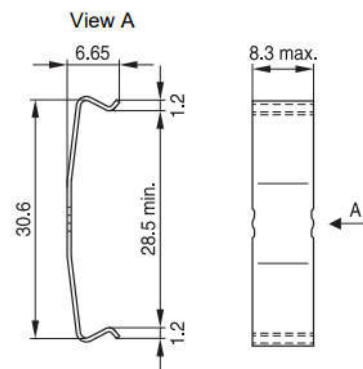

#### Pin 1 marking

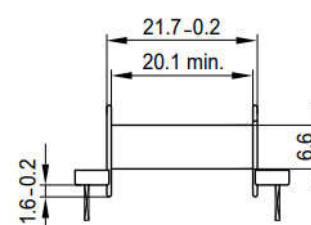
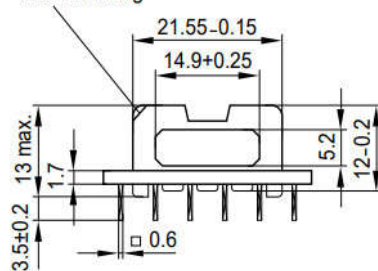

#### EDF30



made in Italy

Via Costamagna 8/A – 12037 SALUZZO (Cn) – ITALY  
Phone +39 0175 249400 / +39 0175 217215 – Fax +39 0175 249814

www.italtras.com italtras@italtras.com

Italtras®